

Easy UPS 3S

10-40 kVA Emergency Lighting

Operation

01/2020



Legal Information

The Schneider Electric brand and any trademarks of Schneider Electric SE and its subsidiaries referred to in this guide are the property of Schneider Electric SE or its subsidiaries. All other brands may be trademarks of their respective owners.

This guide and its content are protected under applicable copyright laws and furnished for informational use only. No part of this guide may be reproduced or transmitted in any form or by any means (electronic, mechanical, photocopying, recording, or otherwise), for any purpose, without the prior written permission of Schneider Electric.

Schneider Electric does not grant any right or license for commercial use of the guide or its content, except for a non-exclusive and personal license to consult it on an "as is" basis. Schneider Electric products and equipment should be installed, operated, serviced, and maintained only by qualified personnel.

As standards, specifications, and designs change from time to time, information contained in this guide may be subject to change without notice.

To the extent permitted by applicable law, no responsibility or liability is assumed by Schneider Electric and its subsidiaries for any errors or omissions in the informational content of this material or consequences arising out of or resulting from the use of the information contained herein.

Table of Contents

Important Safety Instructions — SAVE THESE	
INSTRUCTIONS	5
Electromagnetic Compatibility	6
Safety Precautions	6
Overview	7
User Interface	7
Display Interface	9
Overview of Single UPS	10
Location of Breakers	10
Frequency Converter Mode	14
Operation Procedures	15
Initial Start-Up of the UPS Using the Wizard – Only Applicable to Single UPSs with Internal Batteries	15
Start-Up Checklist – Only Applicable to Single UPSs with Internal Batteries	16
Configuration	17
Register Your Easy UPS 3S	17
Set the Display Language	17
Set the Date and Time	18
Set the UPS Settings	18
Set the Battery Settings	19
Recommended Settings	20
Set the Life Cycle Monitoring	20
Settings	20
Tests	22
Perform a Battery Maintenance Test	22
Perform a Battery Test	22
Maintenance	23
Parts Replacement	23
Determine if you need a Replacement Part	23
Replace the Dust Filter	23
Troubleshooting	26
View the Active Alarms	26
Buzzer	26
Status and Alarm Messages	26

Important Safety Instructions — SAVE THESE INSTRUCTIONS

Read these instructions carefully and look at the equipment to become familiar with it before trying to install, operate, service or maintain it. The following safety messages may appear throughout this manual or on the equipment to warn of potential hazards or to call attention to information that clarifies or simplifies a procedure.



The addition of this symbol to a “Danger” or “Warning” safety message indicates that an electrical hazard exists which will result in personal injury if the instructions are not followed.



This is the safety alert symbol. It is used to alert you to potential personal injury hazards. Obey all safety messages with this symbol to avoid possible injury or death.

DANGER

DANGER indicates a hazardous situation which, if not avoided, **will result in death or serious injury.**

Failure to follow these instructions will result in death or serious injury.

WARNING

WARNING indicates a hazardous situation which, if not avoided, **could result in death or serious injury.**

Failure to follow these instructions can result in death, serious injury, or equipment damage.

CAUTION

CAUTION indicates a hazardous situation which, if not avoided, **could result in minor or moderate injury.**

Failure to follow these instructions can result in injury or equipment damage.

NOTICE

NOTICE is used to address practices not related to physical injury. The safety alert symbol shall not be used with this type of safety message.

Failure to follow these instructions can result in equipment damage.

Please Note

Electrical equipment should only be installed, operated, serviced, and maintained by qualified personnel. No responsibility is assumed by Schneider Electric for any consequences arising out of the use of this material.

A qualified person is one who has skills and knowledge related to the construction, installation, and operation of electrical equipment and has received safety training to recognize and avoid the hazards involved.

Electromagnetic Compatibility

NOTICE

RISK OF ELECTROMAGNETIC DISTURBANCE

This is a product Category C3 according to IEC 62040-2. This is a product for commercial and industrial applications in the second environment - installation restrictions or additional measures may be needed to prevent disturbances. The second environment includes all commercial, light industry, and industrial locations other than residential, commercial, and light industrial premises directly connected without intermediate transformer to a public low-voltage mains supply. The installation and cabling must follow the electromagnetic compatibility rules, e.g.:

- the segregation of cables,
- the use of shielded or special cables when relevant,
- the use of grounded metallic cable tray and supports.

Failure to follow these instructions can result in equipment damage.

Safety Precautions

DANGER

HAZARD OF ELECTRICAL SHOCK, EXPLOSION OR ARC FLASH

All safety instructions in this document must be read, understood and followed.

Failure to follow these instructions will result in death or serious injury.

DANGER

HAZARD OF ELECTRICAL SHOCK, EXPLOSION OR ARC FLASH

After the UPS system has been electrically wired, do not start up the system. Start-up must only be performed by Schneider Electric.

Failure to follow these instructions will result in death or serious injury.

Overview

User Interface

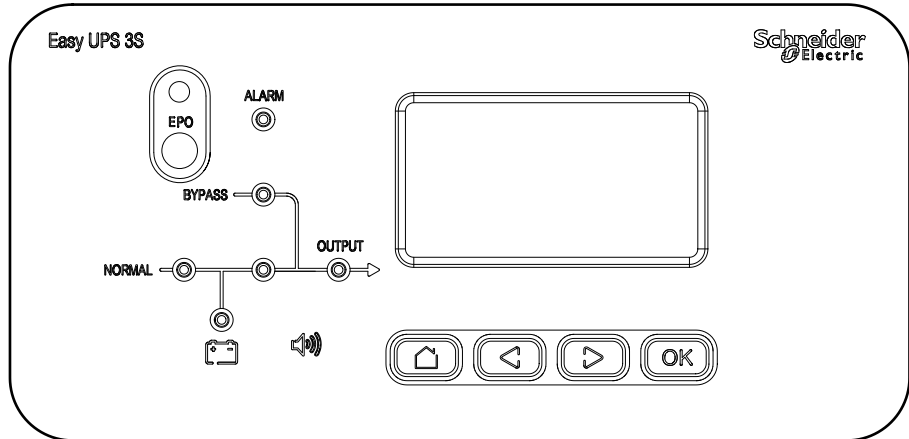

Keys

Home	Previous	Next	Confirm

EPO

Only use the EPO button in case of emergency. When the EPO button is pushed, the system turns off the rectifier and the inverter, and stops supplying the load immediately.

⚠ DANGER









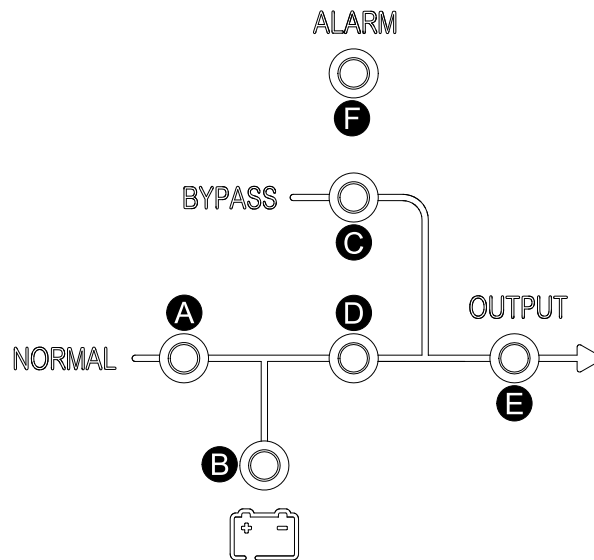







HAZARD OF ELECTRIC SHOCK, EXPLOSION, OR ARC FLASH









The UPS control circuit will remain active after the EPO has been pushed if mains is available.

Failure to follow these instructions will result in death or serious injury.

Status LEDs



	LED	Status
A	Rectifier	Green  : Rectifier is working correctly. Flashing green  : Rectifier is working correctly and mains is normal. Red  : Rectifier is inoperable. Flashing red  : Mains is unavailable. OFF  : Rectifier is off.
B	Battery	Green  : Battery is charging. Flashing green  : Battery is discharging. Red  : Battery is inoperable. Flashing red  : Battery low voltage. OFF  : Battery and battery charger are normal, battery is not charging.
C	Bypass	Green  : Load supplied by bypass source. Red  : Bypass source is unavailable or static bypass switch is inoperable. Flashing red  : Bypass voltage is out of tolerance. OFF  : Bypass source is normal.
D	Inverter	Green  : Load supplied by inverter. Flashing green  : Inverter on, start, synchronization or standby (ECO mode) for at least one module. Red  : Load not supplied by inverter, inverter is inoperable.







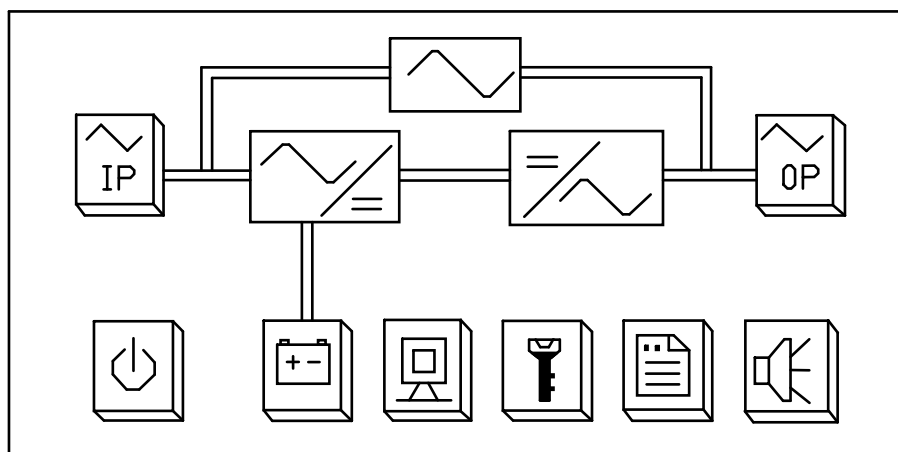

	LED	Status
		Flashing red  : Load supplied by inverter, but an inverter alarm is present. OFF  : Inverter is off.
E	Load	Green  : UPS output is on. Red  : Overload on UPS output for too long, or output has shorted, or no output power present. Flashing red  : Overload on UPS output. OFF  : UPS output is off.
F	Status	Green  : Normal mode. Red  : Inoperable status.

Display Interface

Home Screen



Buttons

							
Power On/ Off	Input and bypass status information	Output status information	Battery status information	UPS status	Function settings	Log	Mute

Overview of Single UPS

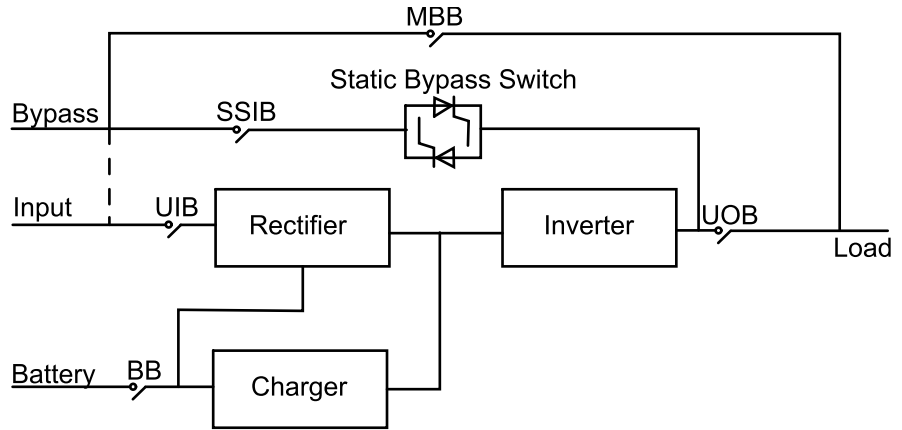

UIB	Unit input breaker
SSIB	Static switch input breaker
UOB	Unit output breaker
MBB	Maintenance bypass breaker
BB	Battery breaker

Location of Breakers

Location of Breakers in 3:3 UPSs

Rear View of the 10–15 kVA UPS for External Batteries

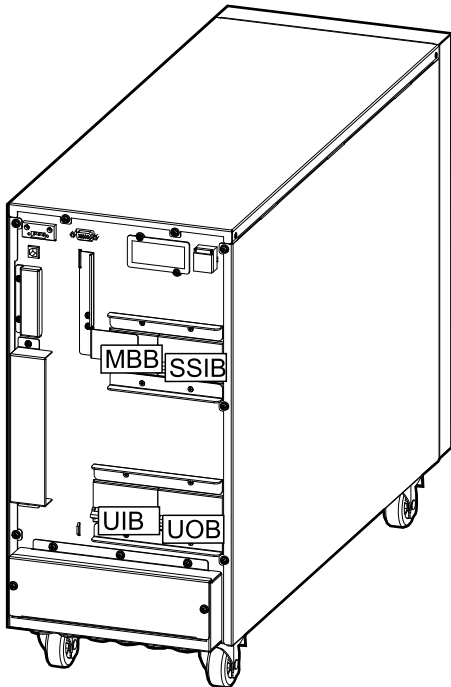

Rear View of the 10–15 kVA UPS with Internal Batteries

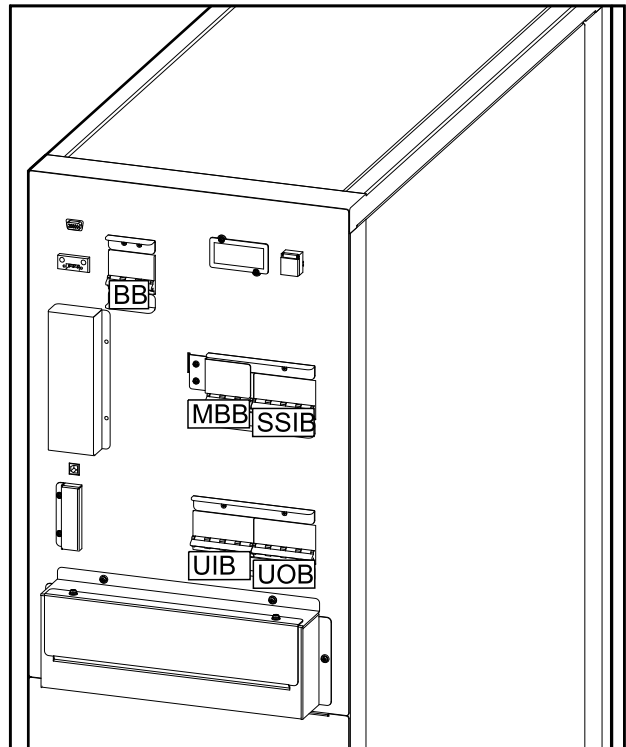

Rear View of the 20 kVA UPS for External Batteries

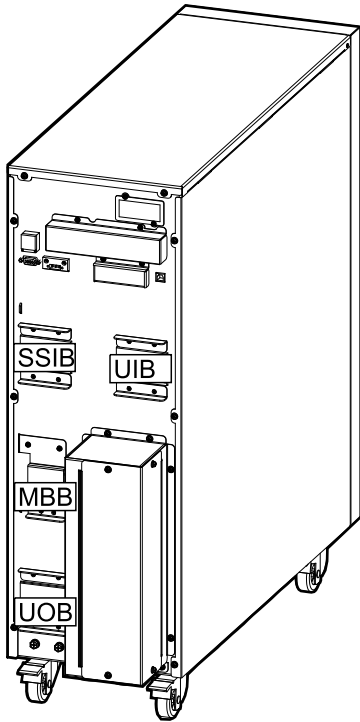

Rear View of the 20 kVA UPS with Internal Batteries

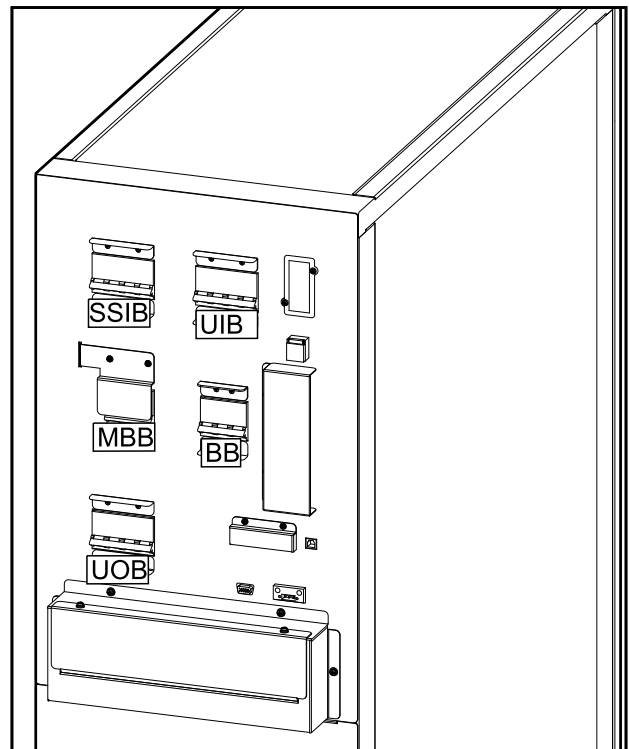

Rear View of the 30 kVA UPS for External Batteries

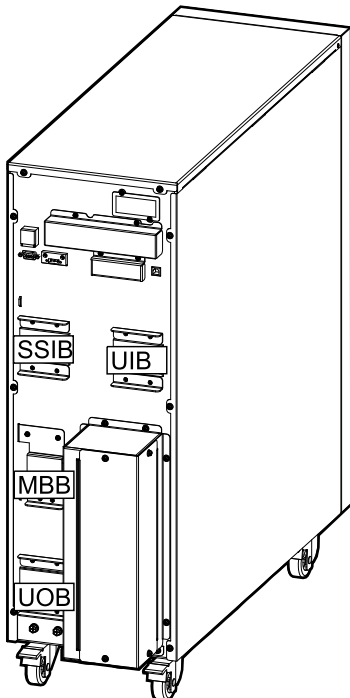

Rear View of the 30 kVA UPS with Internal Batteries

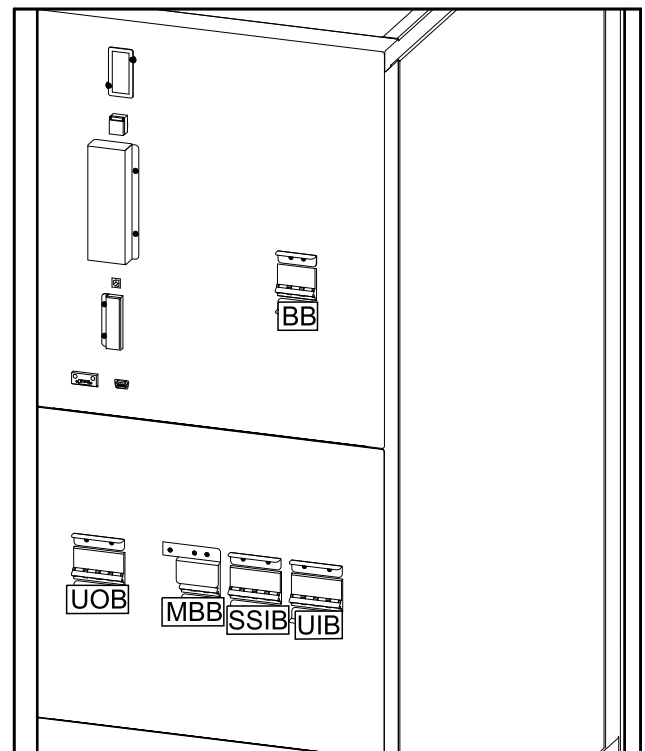

Rear View of the 40 kVA UPS for External Batteries

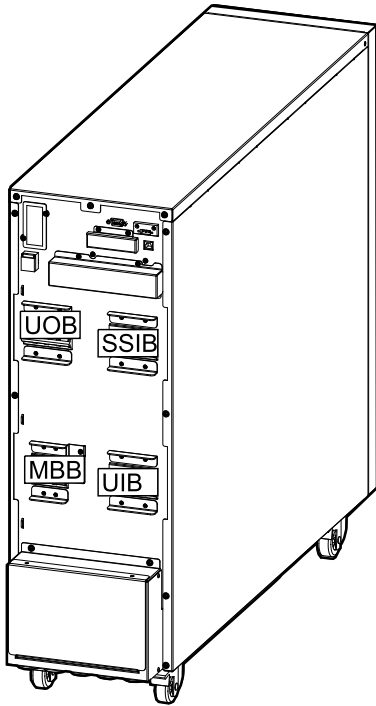

Rear View of the 40 kVA UPS with Internal Batteries

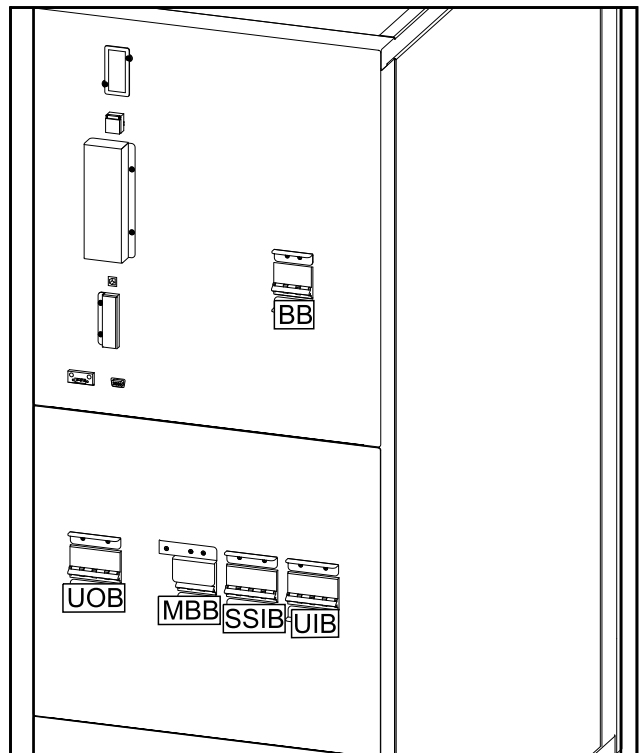

Location of Breakers in 3:1 UPSs

Rear View of the 10–15 kVA UPS for External Batteries

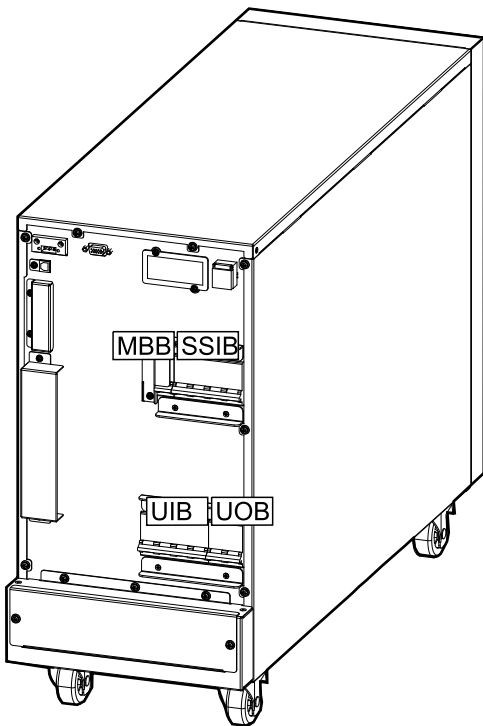

Rear View of the 10–15 kVA UPS with Internal Batteries

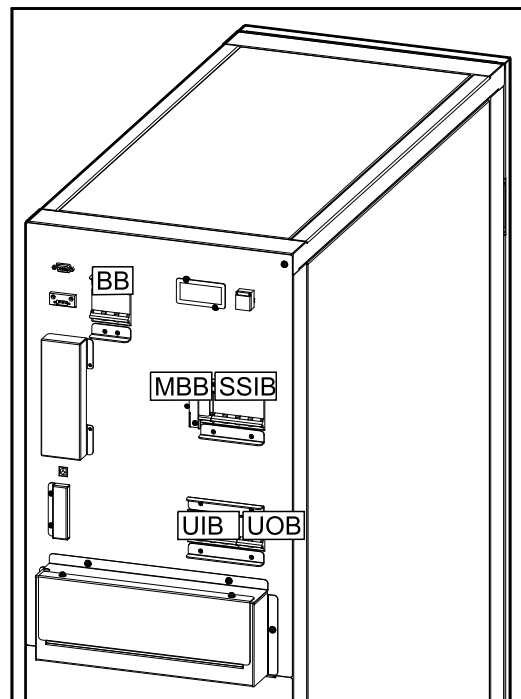

Rear View of the 20 kVA UPS for External Batteries

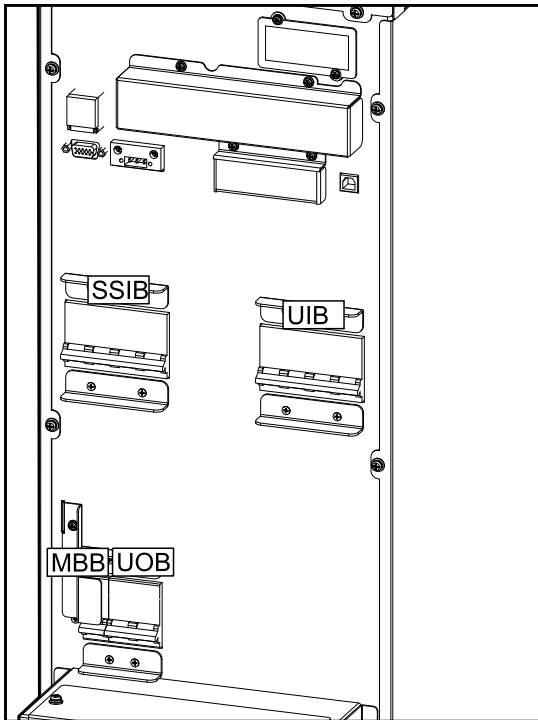

Rear View of the 20 kVA UPS with Internal Batteries

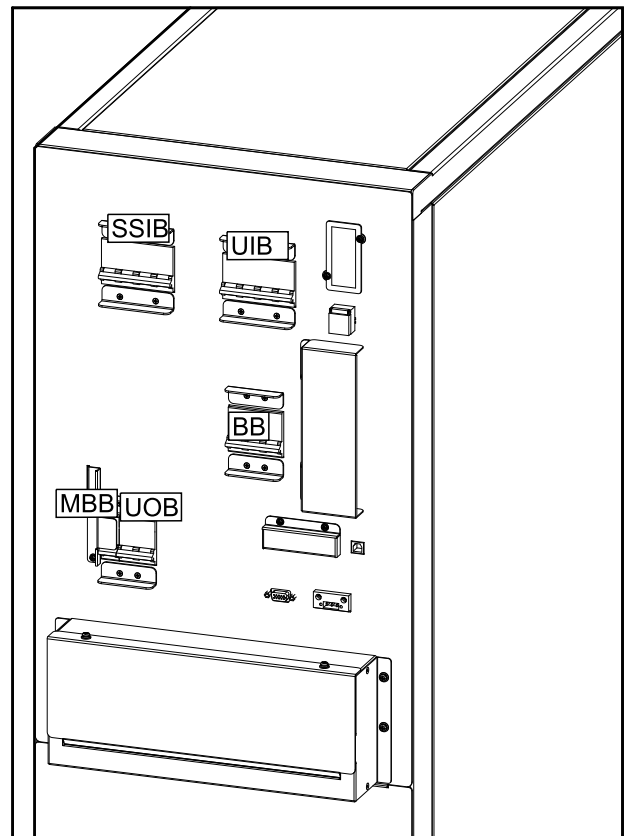

Rear View of the 30 kVA UPS for External Batteries

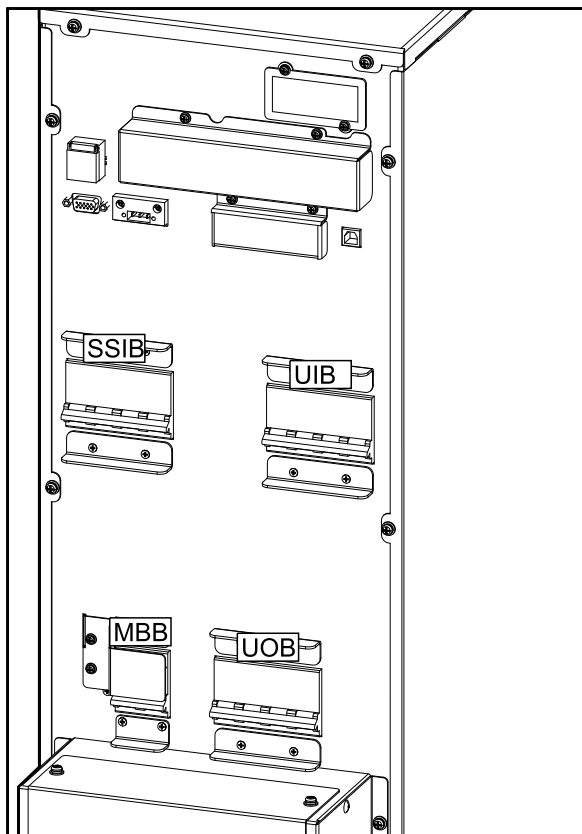

Rear View of the 30 kVA UPS with Internal Batteries

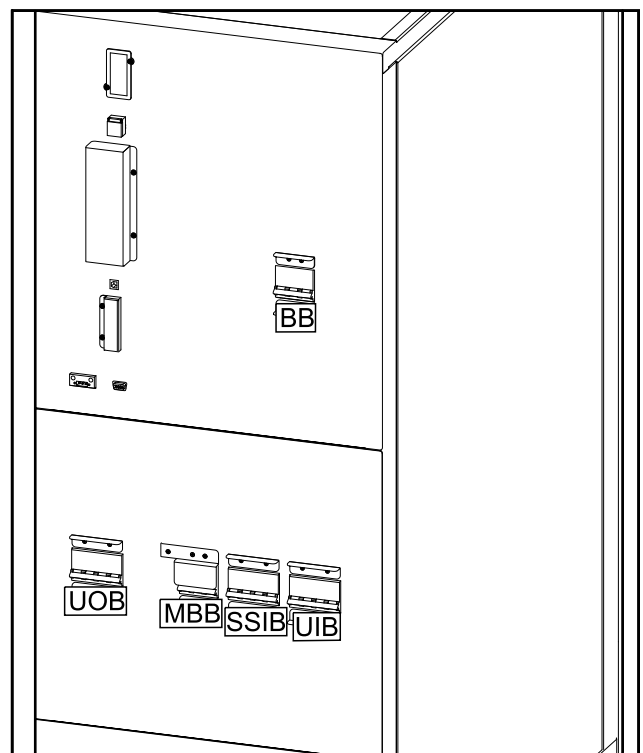

Frequency Converter Mode

In frequency converter mode, the UPS presents a stable output frequency (at 50 or 60 Hz) and the static bypass switch is not available.

NOTICE

RISK OF EQUIPMENT DAMAGE OR LOAD DROP

In frequency converter mode the UPS cannot run in static bypass or maintenance bypass mode. Before turning the UPS into frequency converter mode, you must contact a Schneider Electric-certified partner to make sure

- the static switch input breaker SSIB and the maintenance bypass breaker MBB are in the OFF (opened) position (Schneider Electric strongly recommends to lock these with a padlock available from Schneider Electric)
- no cables are connected to the bypass terminals

Failure to follow these instructions can result in equipment damage.

NOTICE

RISK OF LOAD DROP

When the unit output breaker UOB is opened while the UPS is in frequency converter mode, the load will not be transferred, but will be dropped.

Failure to follow these instructions can result in equipment damage.

LED Status

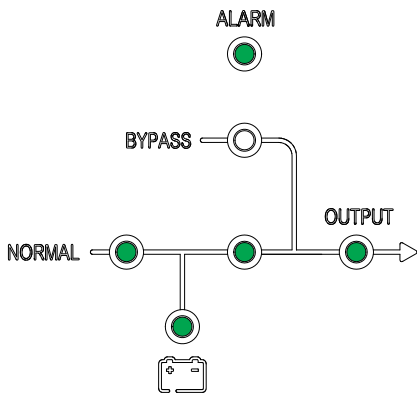

Power Flow

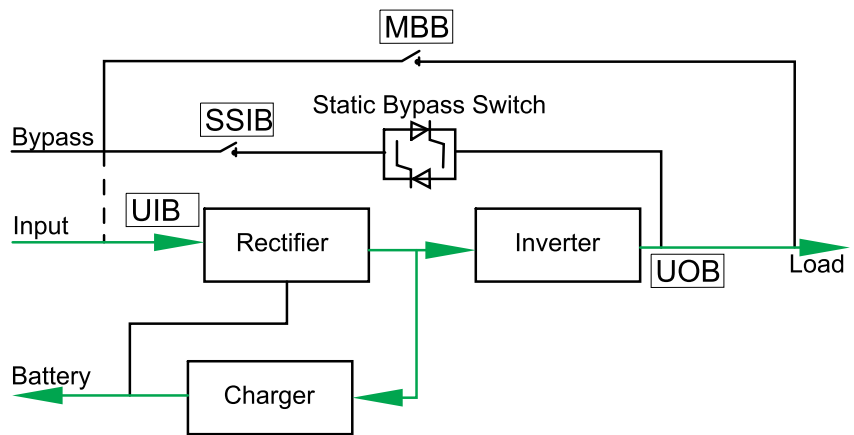

Operation Procedures

Initial Start-Up of the UPS Using the Wizard – Only Applicable to Single UPSs with Internal Batteries

⚠ DANGER

HAZARD OF ELECTRIC SHOCK, EXPLOSION, OR ARC FLASH

Parallel systems and UPSs for external batteries must only be started up by Schneider Electric.

Failure to follow these instructions will result in death or serious injury.

Before starting up the UPS, confirm that:

- The room temperature is between 0 °C to 40 °C
 - The UPS has been installed according to the specified clearance dimensions.
1. Turn the unit input breaker UIB to the ON (closed) position.
The display turns on.
 2. Select to register the UPS or select **Skip** to continue. See *Register Your Easy UPS 3S, page 17* for more information.
 3. When the **Change language** prompt appears, do one of the following:
 - Select **Yes** and select the preferred language using the navigation keys. Select **Yes** again to confirm.
 - Select **No** to keep the current selection.
 4. When the **Change voltage** prompt appears, do one of the following:
 - Select **Yes** and select the preferred voltage using the navigation keys. Select **Yes** again to confirm.
 - Select **No** to keep the current selection.
 5. When the **Change freq.** prompt appears, do one of the following:
 - Select **Yes** and select the preferred output frequency using the navigation keys. Select **Yes** again to confirm.
 - Select **No** to keep the current selection.
 6. When the **Change mode** prompt appears, do one of the following:
 - Select **Yes** and select **Normal mode**, **Parallel mode**, or **Frequency converter mode** using the navigation keys. Select **Yes** again to confirm.
 - Select **No** to keep the current selection.
 7. When the **Save new settings** prompt appears, select **Yes**.
 8. When the **Disable wizard** prompt appears, do one of the following:
 - Select **Yes** to disable the wizard and go to the default screen.
NOTE: Schneider Electric recommends to disable the wizard to allow for automatic start.
 - Select **No** to go to the default screen without disabling the wizard.

Post-requisite: For systems with internal batteries, go to *Set the Battery Settings, page 19*.

Start-Up Checklist – Only Applicable to Single UPSs with Internal Batteries

⚠ DANGER

HAZARD OF ELECTRIC SHOCK, EXPLOSION, OR ARC FLASH

Parallel systems and UPSs for external batteries must only be started up by Schneider Electric.

Failure to follow these instructions will result in death or serious injury.

- I have positioned the UPS according to the installation manual and the recommended clearances are respected.
- I have verified that the environmental conditions including temperature, humidity, and airflow stated in the installation manual are respected.
- I have verified that the input voltage and frequency are within the tolerances specified in the installation manual.
- I have verified that the upstream protection is in accordance with the recommendations in the installation manual and that the power cables have been connected correctly.
- I have installed the batteries as specified in the installation manual.
- I have followed the *Initial Start-Up of the UPS Using the Wizard – Only Applicable to Single UPSs with Internal Batteries, page 15*.
- I have made all settings (including battery settings and life cycle monitoring) described in this manual.
- I have completed all functional tests successfully (normal mode, battery mode, and static bypass mode).
- I have successfully entered the UPS passcode provided by Schneider Electric.
- I confirm the installation has been completed and the UPS is running in normal mode and is powering the load.

Configuration

Register Your Easy UPS 3S

NOTE: The single Easy UPS 3S can also be registered using the mySchneider app which can be downloaded from App Store and Google Play.

1. When prompted for registration, go to *www.schneider-electric.com/contactsupport* to find your local service contact number.



2. On the display, select  and then select **Register**¹.
3. Call Schneider Electric and provide your four-digit activation code.
4. Type in the registration code provided by Schneider Electric.

Register	
Activation	XXXX
Registration code	<input type="text"/>
Register Later	

Set the Display Language



1. On the display, select  and then select **Language**.
2. Select your language from the list:

en: English	pt: Portuguese Brazilian
fr: French	ru: Russian
cn: Simplified Chinese	de: German
it: Italian	es: European Spanish

1. You can also select **Register Later** to postpone your registration

Set the Date and Time



1. On the display, select  and then select **Time**.
2. Set the date and time.

Set the UPS Settings

NOTICE

RISK OF EQUIPMENT DAMAGE

Only trained personnel following the required training course may undertake modifications to UPS system parameters.

Failure to follow these instructions can result in equipment damage.



1. On the display, select  and then select **Setting**.
2. Enter the password **3526**.

Back	←	Settings	→	Next
Enter password				
<input type="text" value="3526"/>				

3. Set the nominal input voltage (phase-neutral), the nominal output voltage (phase-neutral), and the nominal frequency.

Back	←	Settings	→	Next
Nom input PN		XXX		
Nom output PN		XXX		
Nom freq		XX		
Code		11776		

4. Restart the UPS to activate the settings.

Set the Battery Settings

NOTICE
<p>RISK OF EQUIPMENT DAMAGE</p> <ul style="list-style-type: none"> Only trained personnel following the required training course may undertake modifications to UPS system parameters. The battery parameters must set according to the actual installation before starting up the UPS. <p>Failure to follow these instructions can result in equipment damage.</p>



1. On the display, select and then select **Batt Settings**.
2. Enter the password **2334**.

Back Batt Settings Next
Enter password 2334

3. Set the battery settings:
 - a. **Batt number**: Set the number of battery blocks in one battery string.
 - b. **Batt cap (AH)**: Set the battery capacity (battery block capacity (AH) x number of battery strings).²
 - c. **Batt charge %**: Set the battery charge percentage (between 1% and 20%).

Back Batt Settings Next						
<table style="width: 100%; border: none;"> <tr> <td style="width: 60%;">Batt number</td> <td style="text-align: right;">XX</td> </tr> <tr> <td>Batt cap (AH)</td> <td style="text-align: right;">XXX</td> </tr> <tr> <td>Batt charge %</td> <td style="text-align: right;">XX</td> </tr> </table>	Batt number	XX	Batt cap (AH)	XXX	Batt charge %	XX
Batt number	XX					
Batt cap (AH)	XXX					
Batt charge %	XX					

² In a 1+1 redundant parallel system with a common battery bank, insert half of the battery capacity in each UPS.

Recommended Settings

	Batt number	Battery String	Batt cap (AH)	Batt charge %
QCGA99400 E3SUPS10	36 (SWL750)	1	25	12.2
QCGA48503 E3SUPS10	34 (SWL1100)	1	40.6	18.7
QCGA04777 E3SUPS15	36 (SWL1100)	1	40.6	13.2
QCGA11857 E3SUPS15	32 (XP12V2500)	1	69.5	20
QCGA96752 E3SUPS20	36 (XP12V1800)	1	56.4	13.7
QCGA50574 E3SUPS20	32 (XP12V3000)	1	92.8	20
QCGA73617 E3SUPS30	32 (XP12V3000)	1	92.8	13.4
QCGA30699 E3SUPS30	40 (XP12V3000)	1	92.8	16.8
QCGA47755 E3SUPS40	40 (XP12V3000)	1	92.8	12.6

Set the Life Cycle Monitoring

NOTICE
RISK OF EQUIPMENT DAMAGE
Only trained personnel following the required training course may undertake modifications to UPS system parameters.
Failure to follow these instructions can result in equipment damage.



1. On the display, select and then select **LCM Set**.
2. You now have the following options:

Back	LCM SET	Next
Set dust filter expiration: XX months		

- Select **Set dust filter expiration** to set the service life of the dust filter.

Settings

Setting	Default Value	Available Settings
LCD contrast	60	0 to 100
Date and Time	05/07/2013 08:55:55	Year > 2000
Language	English	Chinese simplified, English, Italian, German, Russian, Spanish, Portuguese Brazilian, and French
Input voltage	400 V	380 V/400 V/415 V
Bypass voltage	400 V for 3:3 UPSs	380 V/400 V/415 V for 3:3 UPSs

Setting	Default Value	Available Settings
	230 V for 3:1 UPSs	220 V/230 V/240 V for 3:1 UPSs
Input frequency	50 Hz	60 Hz
Output voltage	400 V for 3:3 UPSs 230 V for 3:1 UPSs	380 V/400 V/415 V for 3:3 UPSs 220 V/230 V/240 V for 3:1 UPSs
Output frequency	50 Hz	60 Hz
Output phase	3 for 3:3 UPSs 1 for 3:1 UPSs	3/1
Auto boost	disable	enable
Auto maint	disable	enable
System mode	single	parallel/ECO/parallel ECO/self aging
United number	1	1 to 4
System ID	0	0 to 3
Adjusted output voltage	400 V for 3:3 UPSs 230 V for 3:1 UPSs	Output voltage ± 10 V
Frequency slew rate	2 Hz/s	0.1 to 5.0 Hz/s
Frequency synchronization window	3 Hz	0.5 to 5.0 Hz
Monochrome LCD time (min)	10	1/3/5/10/20/30
Bypass voltage upper limit (%)	15	10/20/25
Bypass voltage lower limit (%)	-20	-10/-15/-30/-40
Bypass frequency limited (Hz)	± 5	$\pm 1/\pm 3/\pm 5$
System restart mode after end of discharge	Normal	bypass only/ no output
Fan maintenance period	34560 hours (48 months)	0 to 60000 hours
DC capacitor maintenance period	34560 hours (48 months)	0 to 60000 hours
warranty period	9 months	1 to 36 months
AC capacitor maintenance period	120 months	60 to 120 months
APS maintenance period	84 months	36 to 120 months
Dust filter maintenance period	3 months	0/3/4/5/12 months
Battery maintenance period	1440 days (48 months)	100 to 3000 days
Battery number	32 for UPSs for external batteries 40 for UPSs with internal batteries	32/34/36/38/40
Battery AH	1	1 to 30000
Float charge voltage/cell (V)	2.25	2.10 to 2.35
Boost charge voltage/cell (V)	2.25	2.20 to 2.45
End of discharge voltage/cell, at 3 C current (V)	1.65	1.50 to 1.85
End of discharge voltage/cell, at 0.05 C current (V)	1.75	1.55 to 1.90
Charge current percent limit (%)	10	1 to 20
Battery temperature compensation	0	0 to 5 mV/°C
Boost charge time limit	12 hours	1 to 48 hours
Auto boost period	2160 hours (3 months)	720 to 30000 hours, available when auto boost is enabled
Auto maintenance discharge period	6480 hours (9 months)	720 to 30000 hours, available when auto maintenance is enabled
Critical battery temperature	45 °C	25 °C to 70 °C
Critical ambient temperature	40 °C	25 °C to 70 °C

Tests

Perform a Battery Maintenance Test

Prerequisite:

- The bypass supply must be within specifications.
- The battery capacity must be above 25%.

The battery maintenance test is used to test the condition of the batteries.

During the battery maintenance test, the system transfers to battery mode and discharges the batteries until the battery low voltage alarm is reached.



1. On the display, select  and then select **Maint test**.

NOTE: If you wish to manually stop the battery test, select **Stop test**.

If the battery maintenance test is passed, **Battery maintenance OK** will be recorded in the log. If the battery maintenance test is not passed, **Batt maint incomplete** will be recorded in the log.

Perform a Battery Test

The purpose of the battery test to verify the connection of the batteries and to check the battery capacity.

Prerequisite:

- The bypass supply must be within specifications.
- The battery capacity must be above 25%.
- The battery voltage must be above 95% of the float voltage.

During the battery test, the system transfers to battery mode for approximately 30 seconds and then returns to normal mode.



1. On the display, select  and then select **Battery test**.

Maintenance

Parts Replacement

Determine if you need a Replacement Part

To determine if you need a replacement part, contact Schneider Electric and follow the procedure below so that the representative can assist you promptly:

1. In the event of an alarm condition, scroll through the alarm lists, record the information, and provide it to the representative.
2. Write down the serial number of the unit so that you will have it easily accessible when you contact Schneider Electric.
3. If possible, call Schneider Electric from a telephone that is within reach of the display so that you can gather and report additional information to the representative.
4. Be prepared to provide a detailed description of the problem. A representative will help you solve the problem over the telephone, if possible, or will assign a return material authorization (RMA) number to you. If a module is returned to Schneider Electric, this RMA number must be clearly printed on the outside of the package.
5. If the unit is within the warranty period and has been started up by Schneider Electric, repairs or replacements will be performed free of charge. If it is not within the warranty period, there will be a charge.
6. If the unit is covered by a Schneider Electric service contract, have the contract available to provide information to the representative.

Replace the Dust Filter

1. Lift the front panel free of the UPS cabinet.

NOTE: Be careful not to disconnect the cable on the rear side of the front panel.

2. Loosen the screws and remove the metal brackets.

UPS for External Batteries

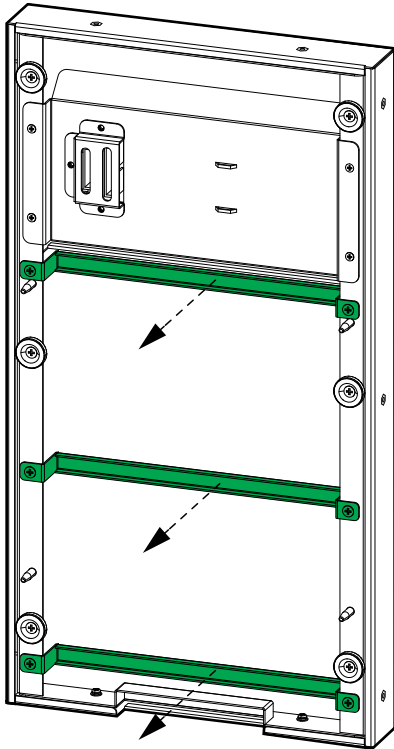

UPS with Internal Batteries

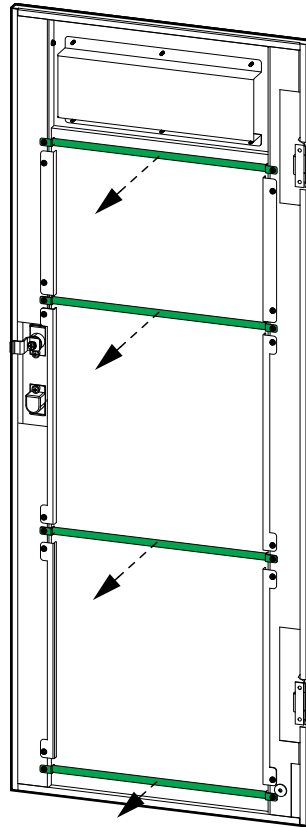

3. Replace the dust filter.

UPS for External Batteries

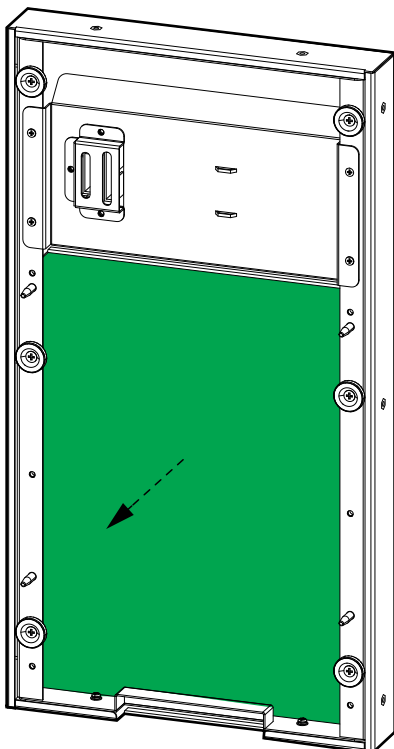

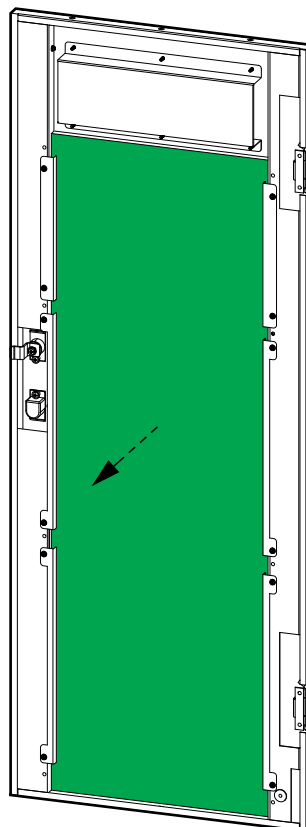

UPS with Internal Batteries



4. Reinstall the metal brackets and fasten with the screws.
5. Reinstall the front panel.
6. Reset the dust filter time in the display. See *Set the Life Cycle Monitoring*, page 20 for more information.

Troubleshooting

View the Active Alarms

1. On the display select .
See *Status and Alarm Messages*, page 26 for a list of alarm messages and corrective actions.
2. Use  and  to go through the list of active alarms.

Buzzer

NOTE: The buzzer turns on as soon as an alarm condition is detected. The buzzer makes two short beeps and a long beep for general system alarms. The buzzer makes a continuous beep for critical alarms. It can be turned off by

selecting  on the home screen.

Status and Alarm Messages

This section lists status and alarm messages from the display. The display messages are listed in alphabetical order, and a suggested corrective action is listed with the display alarm message to help you troubleshoot problems.

Display text	Description	Corrective action
Battery boost charging	The batteries are charged with the configured boost charge voltage.	
Battery connected	The batteries are connected.	
Battery discharging	The load is drawing more power than the UPS can draw from the input, causing the UPS to draw power from the batteries.	Reduce the load. Please contact Schneider Electric.
Battery disconnected	The batteries are not connected.	Connect the batteries.
Battery expired	The battery service life has expired.	Replace the battery.
Battery end of discharge	The battery capacity is below the minimum acceptable value.	Recharge the batteries.
Battery float charging	The batteries are charged with the configured float charge voltage.	
Battery log reset	Reset the battery log.	
Batt maint incomplete	The battery maintenance test was not passed.	
Battery maintenance	Start the battery maintenance test.	
Battery maintenance OK	The battery maintenance test has been successfully completed.	
Battery temperature high	The battery temperature is too high.	Check the battery temperature.
Battery test	Start the battery test.	

Display text	Description	Corrective action
Battery test incomplete	The battery test was not passed.	
Battery test OK	The battery test has been successfully completed.	
Battery voltage low	Low voltage on battery.	Check the battery.
Battery wiring incorrect	The battery wiring is incorrect.	Check the battery wiring. Please contact Schneider Electric.
Battery/charger inoperable	The battery or charger is inoperable.	Check the battery. Check the charger. Please contact Schneider Electric.
Byp freq exceeds limits	The bypass frequency exceeds the limit.	Check the status of the bypass source. Please contact Schneider Electric.
Bypass fan inoperable	The UPS has one or more inoperable fans.	Check the fans.
Bypass fan time reset	Reset the service life timer for the fan.	
Bypass out of tolerance	The bypass voltage is out of tolerance.	Check the status of the bypass source. Please contact Schneider Electric.
Bypass overload	The load is drawing more power than the bypass source can supply.	Reduce the load. Please contact Schneider Electric.
Bypass overload timeout	The UPS can no longer sustain a Bypass overload situation.	Reduce the load. Please contact Schneider Electric.
Bypass sequence incorrect	The phase rotation on bypass is incorrect.	Check the status of the bypass source. Please contact Schneider Electric.
Bypass unavailable	The bypass source is not available.	Check the status of the bypass source. Please contact Schneider Electric.
Capacitor expired	Capacitor service life has expired.	Replace the capacitor.
Capacitor time reset	Capacitor service life timer has been reset.	
Clear log	Clear the log.	
DC bus overvoltage	Overvoltage on the DC bus.	
Dust filter expired	The dust filter service life has expired.	<i>Replace the Dust Filter, page 23.</i>
EPO	An EPO (emergency power off) device is activated.	Deactivate the EPO (emergency power off) device.
Fan expired	Fan service life has expired.	Replace the fan.
Fan inoperable	The UPS has one or more inoperable fans.	Check the fans. Please contact Schneider Electric.
Fan time reset	The fan service life timer has been reset.	
Firmware incompatible	The firmware is detected as incompatible with the rest of the system.	Perform a firmware update.
Generator input	Generator is supplying the UPS.	
Inhibit transfer to inv.	Inhibit transfer to inverter operation.	

Display text	Description	Corrective action
Inlet temperature high	Air inlet temperature is too high.	Check the status of the air inlet. Reduce the room temperature.
Inlet/outlet temp	Air inlet and outlet temperature.	
Input current unbalanced	Input current is unbalanced.	Check the status of the input source. Please contact Schneider Electric.
Input neutral unavailable	Input neutral is not available.	Check the status of the input neutral. Please contact Schneider Electric.
Input out of tolerance	The input voltage is out of tolerance.	Check the status of the input source. Please contact Schneider Electric.
Input overcurrent timeout	The UPS can no longer sustain an Input overcurrent situation.	Check the status of the input source. Please contact Schneider Electric.
Input SCR fan inoperable	Input SCR fan is inoperable.	Check the status of the input SCR fan. Please contact Schneider Electric.
Input SCR temp high	Input SCR temperature is too high.	Check the status of the input SCR fan. Please contact Schneider Electric.
Inverter high temp	Inverter temperature is too high.	Check the status of the inverter. Please contact Schneider Electric.
Inverter IGBT inoperable	The inverter IGBT is inoperable.	Check the status of the inverter IGBT. Please contact Schneider Electric.
Inverter inoperable	The inverter is inoperable.	Check the status of the inverter. Please contact Schneider Electric.
Inverter overload timeout	The UPS can no longer sustain an Inverter overload situation.	Check the status of the inverter. Please contact Schneider Electric.
Inverter shutdown	The inverter is shutting down.	
Inv DATA CAN incorrect	Inverter DATA CAN is incorrect.	
Inv IO CAN incorrect	Inverter IO CAN is incorrect.	
Load on bypass	The UPS is in static bypass mode and the load is supplied by the bypass source.	
Load disconnected	The load has been disconnected or the unit output breaker UOB is open.	Check the load. Close the unit output breaker UOB.
Load on inverter	The UPS is in inverter operation mode and the load is supplied by the UPS.	
Low battery shutdown	The UPS is shutting down due to battery end of discharge	Recharge the batteries and restart the UPS. If auto-restart mode is configured, the UPS will start automatically restart when the mains return.
Man. transfer to inverter	Manual transfer to inverter operation.	
Manual shutdown	Manual shutdown.	
MBB closed	The maintenance bypass breaker MBB is closed, supplying the load	

Display text	Description	Corrective action
	with unprotected power from the bypass source.	
MBB open	The maintenance bypass breaker is open.	
Module ID duplicate	The module ID has a duplicate. The module ID must be unique.	Check the ID of the modules.
No inlet temp sensor	No inlet temperature sensor present.	Check the status of the inlet temperature sensor.
No input temp sensor	No input temperature sensor present.	Check the status of the input temperature sensor.
No outlet temp sensor	No outlet temperature sensor present.	Check the status of the outlet temperature sensor.
Nom power out of tolerance	Input is out of tolerance	Check the status of the input source. Please contact Schneider Electric.
Outlet temperature high	Air outlet temperature is too high.	Check the status of the air outlet. Please contact Schneider Electric.
Output short circuit	A short circuit is present on the output.	Check the status of the output. Please contact Schneider Electric.
Output overload	The load is drawing more power than the UPS system can supply.	Reduce the load. Contact Schneider Electric.
Parallel cabling incorrect	The parallel cabling is incorrect.	Check the status of the parallel cables. Please contact Schneider Electric.
Power sharing incorrect	The power sharing between the UPS units is incorrect.	Please check the load sharing on the UPS units. Redistribute the load between UPS units. Please contact Schneider Electric.
PWM sync unavailable	The PWM synchronization is unavailable.	Check the status of the PWM sync. Please contact Schneider Electric.
Rec soft start unavailable	The rectifier soft start is unavailable.	Check the status of the rectifier. Please contact Schneider Electric.
Rectifier high temp	The rectifier temperature is too high.	Check the status of the rectifier. Please contact Schneider Electric.
Rectifier inoperable	The rectifier is inoperable.	Check the status of the rectifier. Please contact Schneider Electric.
Relay disconnected	A relay is disconnected.	Check the status of the relays. Please contact Schneider Electric.
Relay short-circuit	A relay has short-circuited.	Check the status of the relays. Please contact Schneider Electric.
Room temp high	The room temperature is high.	Reduce the room temperature.
Shutdown	UPS shutdown.	
Signal cable disconnect	Signal cable is disconnected.	Check the signal cable.
Sync pulse unavailable	Sync pulse is unavailable. The UPS is not able to synchronize.	Check the sync pulse. Please contact Schneider Electric.
System overload	The load is drawing more power than the UPS system can supply.	Reduce the load. Contact Schneider Electric.
System setting incorrect	The system settings are incorrect.	Check the system settings. Contact Schneider Electric.

Display text	Description	Corrective action
Technical check recommended	A technical check is recommended.	Contact Schneider Electric.
Transfer to bypass	Transfer the UPS to static bypass mode.	
Transfer to inverter	Transfer the UPS to inverter operation.	
Transfers exceed limits	There have been too many transfers between operation modes in a given time period.	Contact Schneider Electric.
Warranty expiring soon	Warranty is expiring soon.	Contact Schneider Electric.

Schneider Electric
35 rue Joseph Monier
92500 Rueil Malmaison
France

+ 33 (0) 1 41 29 70 00



As standards, specifications, and design change from time to time,
please ask for confirmation of the information given in this publication.

© 2020 – 2020 Schneider Electric. All rights reserved.

990-91364-001